

REPRESENTING

Main Suppliers & Partners

- Behrens
 - BORNEMANN
DOMINATOR
 - ProMinent/ORLITA
 - FLUID
 - KRAL
 - Shinko
 - SEEPEX
 - SONDEX
 - SPECK
 - SPECK-Triplex
 - SUNDSTRAND

 - RUHRPUMPEN
 - VATEC MASCHINENBAU
 - WEPUKO HYDRAULIC
 - WOMA APPARATEBAU
- Ship Pumps**
 - Multiphase-Twin Screw Pumps,(API 676)
 - Diaphragm Pumps (air driven)
 - Dosing pumps, Membrane (API 674/675)
 - Agitators
 - Twin screw pumps (API 676)
 - Cargo & Ballast Pumps
 - Eccentric Screw Pumps (API 676)
 - Heat exchangers
 - Centrifugal Pumps (single & multistage)
 - Piston Pumps (Norm/ ISO)
 - Compact high speed Centrifugal
Pumps & Compressors (API 610/614/617)
 - Centrifugal Pumps (API 610)
 - Ejectors
 - Triplex plunger pumps (API 674)
 - High Pressure Water Jet technique

www.pergjerdrum.no



2

Bornemann Pumps

World leading manufacturer of:

- Twin screw pumps (API 676)
- Multiphase Topside and Subsea twin screw pumps
- Self-priming, rotary positive displacement pumps
- Wide range of applications for most media and fluids
- Operates pulsation- and turbulence-free
- Pumped capacity is proportional to speed
- Constant flow on varying pressures
- Very good suction performance up to NPSH 1 - 1,5 m/3 (Selfpriming)
- Low noise level
- Dry running possible
- Compact construction
- Easy maintenance

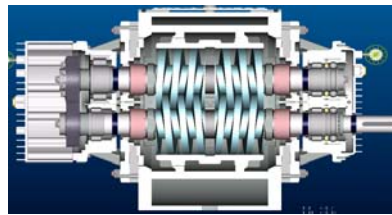

www.pergjerdum.no



3



ProMinent®

ProMinent -Leading Manufacturer of Chemical Injection Pumps

- **High pressure diaphragm pumps**
- **DR – Pump for high viscosities**
- **Pressures up to 700 bar**
- **API 675 (API 674)**

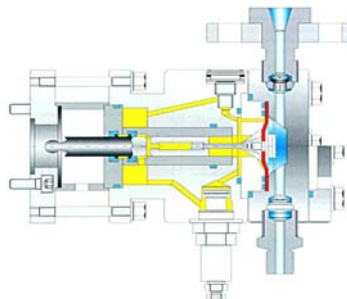

www.pergjerdum.no



4



World leading manufacturer of process pumps:

- API 610 (Horizontal/Vertical)
- Non API (Horizontal/Vertical)
- Single, multistage, submerged etc.

- Applications for pumping;
 - Hydrocarbons
 - Chemical solutions
 - Inorganic or organic acids
 - Produced Water
 - Propane
 - Caustic solutions
 - Condensate
 - Sea Water, Fresh Water etc.

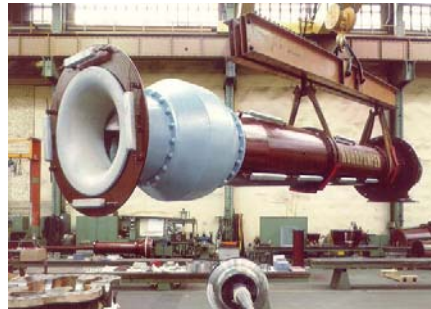

Vertical, single stage mixed flow pump, type TR for pumping cooling water /sea water lift for petrochemical plants



Crude Oil Booster Pumps, API 610 Centrifugal, vertical inline

www.pergjerdrum.no



5

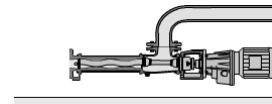

Progressive Cavity Pumps

- Worldwide leading manufacturer of progressive cavity pumps (PCP), API 676
- Production facilities in Germany, USA and China
- Multiphase Pumps, also for Mud and Drill cuttings
- Handle any kind of liquids
- Selfpriming
- Reversible
- Versatile use in all industries

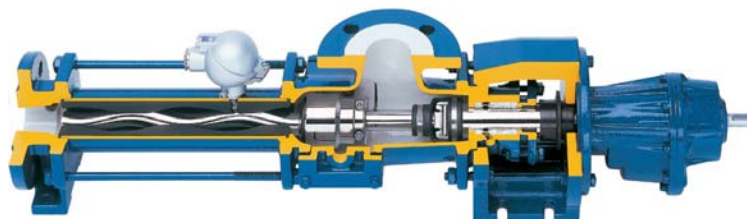

www.pergjerdrum.no



6



World leading manufacturer of process pumps:

- Direct drive, API 610 (Horizontal/Vertical in-line)
- High speed drive, API 610 (Horizontal/Vertical in-line)
- High speed DIN/ISO pumps

Advantages:

- Heavy duty wet-end
- Compact, lightweight
- Low capacity – very high head
- Suitable for low NPSHa applications
- Modular concept, easy maintenance

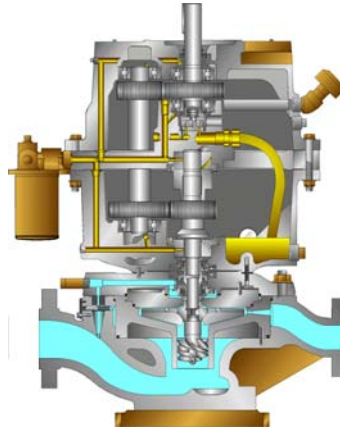

www.pergjerdrum.no



7



World leading manufacturer of process gas compressors:

- LMC Single stage integrally geared vertical in-line
- Pinnacles: Horizontal multistage integrally geared API614/617
- Vapour Recovery
- Regeneration
- Recycle
- Fuel Gas, Nitrogen, CO₂, Ammonia, Chloride etc



8

HMD Kontro

SEALLESS PUMPS



- **Magnetic driven pumps (API 610/685)**
 - Almost no unplanned maintenance for low cost operation
 - Uses standard electric motors to reduce initial / replacement costs
 - No leakage possible - Environmentally safe
 - High pressures and hot oil capabilities without 'backup' systems for versatility
 - All specifications available ISO 2858, DIN, EN22858: 1993, ANSI B73.1M, B73.3M and API 610 / 685
 - Non - metallic versions are available to suit your application.
 - Can be serviced on site to reduce cost and downtime
 - No cooling required

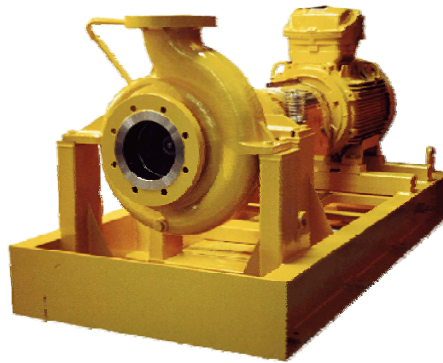

www.pergjerdrum.no

 **Pumps**
Ing. Per Gjerdrum AS

9

SPECK - PUMPEN

Daniel Speck & Söhne GmbH & Co. KG
Lohbachstr. 6 - D-91161 Hilpoltstein



- All type of Centrifugal pumps for process – and utility applications
- Standard DIN/ANSI/Norm pumps
 - Vertical
 - Horizontal
 - Inline version
 - Canned version
 - Multistage
 - Submerged



www.pergjerdrum.no

 **Pumps**
Ing. Per Gjerdrum AS

10

wepuKO hydraulik

- **Triplex Piston Pumps API 674**

- DP-400 Series
- DP-212 Series'

High capacity – high pressures

- **Process injection for**

- Produced Water
- Chemicals
- MEG / Methanol
- Diesel etc.



Methanol injection Snorre B platform



www.pergjerdrum.no



11



PG Construction AS

Fab.facility in Lier, Drammen
30 min west of Oslo

- **Manufacturer of marine and offshore constructions and products**
 - Manufacturing of Pump packages/ pumping systems
- **Design and engineered in close cooperation with our Clients**
- **Fabrication Facility**
 - Total Manufacturing 2100m2 + offices
 - Crane capacity: 3 Ton and 12 ton(Height 5,5m)
 - New Facility for Assembly - mounting – testing Total 1800m2
 - Crane capacity 50 ton (Height 8m)
 - Inconel cladding of flanges and hubs for Offshore/ Subsea
 - 1 x 1.2 x 2,6 meter rotary fizzle-drill machine
 - 1250 mm milling capacity
 - Co-operation with Teknisk Produksjon AS (CNC machinery)
 - Welding – WPQR in Mild steel-stainless steel-copper-Duplex
- 28 employees
- www.pg-construction.com



www.pergjerdrum.no



12



Hydraulics AS

- **Product range**
 - Complete hydraulic systems engineering
 - Building of Hydraulic Power Packs
 - Distribution of hydraulic components and solutions
 - Production of hydraulic hoses in acc. with Customer specifications
 - Commissioning and Service
- **New Facilities, 2008**
 - Eggesbønes, Fosnavåg
 - Total 1400 m²
 - Workshop 1000 m²
 - Offices 400 m²
- **Crane capacity**
 - 2 cranes of 2 x 10 t (40 tons total)
 - Lifting height 7 m
- **PG-Hydraulics AS**
 - Owned by PG and Ulstein Marine Technology as
 - 12 employees
- www.pg-hydraulics.com



www.pergjerdrum.no



13

Ing. Per Gjerdrum AS